

Ceramic PTC Thermistor: PSB Series

Case Type for Inrush Current Limiter



■ Features

1. RoHS compliant
2. Voltage ratings: 140V_{ac} to 560V_{ac}
3. Resistance range: 10~100Ω
4. Stable over a long life
5. Operating temperature range:
 - 20 ~ +85°C (V=V_{max})
 - 40 ~ +125°C (V=0)
6. Agency recognition:
 - UL&cUL File No. E138827
 - VDE File No. 40017625



■ Recommended Applications

Inverter Air Conditioner

■ Part Number Code

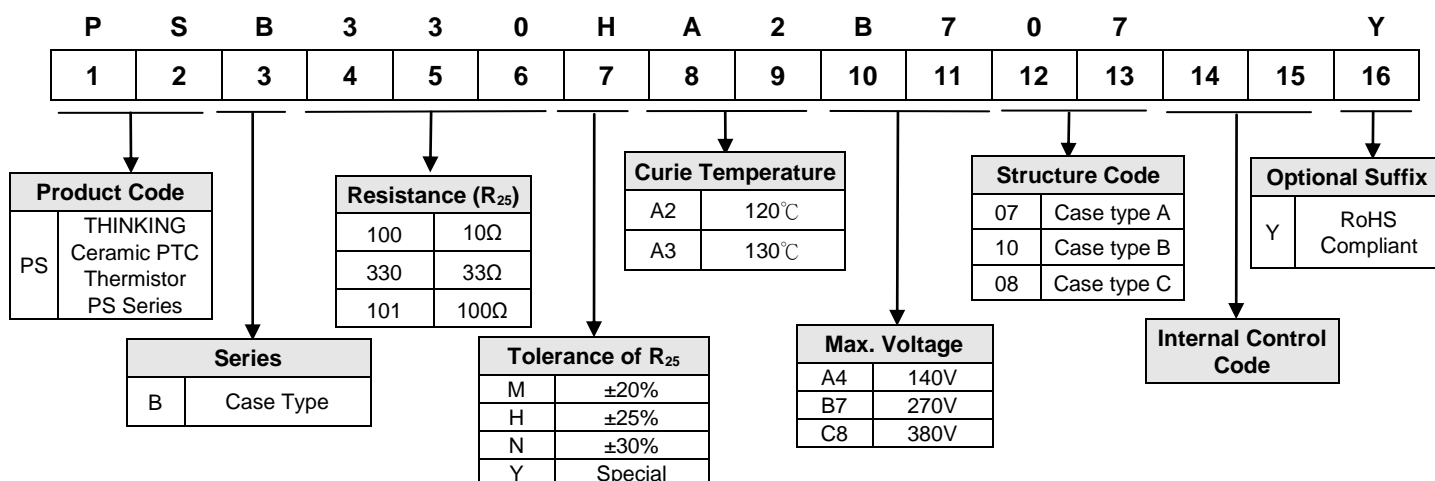

■ Structures and Dimensions

Case Type: A

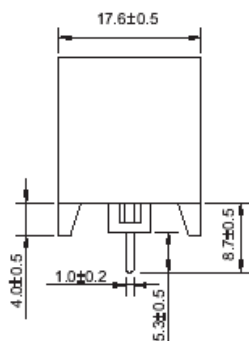

Case Type: B

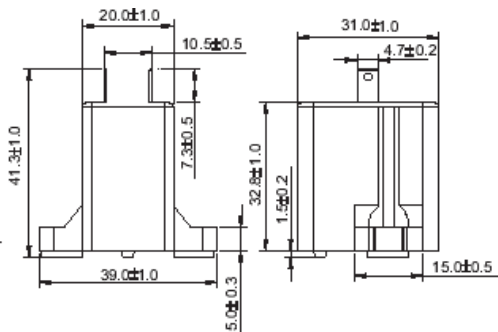

Case Type: C

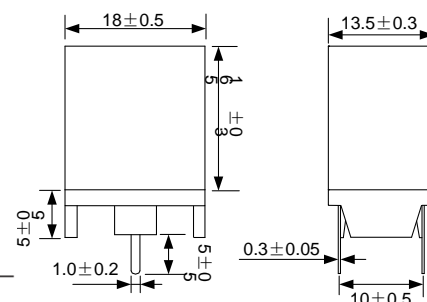

(Unit: mm)

Note: The case types are typical types, and please contact your sales representatives if you have any other requests.

Ceramic PTC Thermistor: PSB Series

Case Type for Inrush Current Limiter



■ Characteristics

Part No.	Case Type	Max. Voltage	Max. Link Voltage	Zero-power Resistance at 25°C	Curie Temperature	Heat Capacity	Max Non-operating Energy at 60°C	Safety Approvals	
		V _{max} (V _{ac})	V _{Lmax} (V _{dc})	R ₂₅ (Ω)	T _c (°C)	C _{th} (J/K)	E _{Non60} (J)	UL/cUL	VDE
PSB100□A2A407	A	140	200	10	120	0.95	40		√
PSB100□A2A410	B	140	200	10	120	3.2	134		√
PSB150□A2A407	A	140	200	15	120	0.95	40		√
PSB200□A2A407	A	140	200	20	120	0.95	40	√	√
PSB220□A2A407	A	140	200	22	120	0.95	40		√
PSB150□A2B710	B	270	380	15	120	3.2	134		√
PSB220□A2B710	B	270	380	22	120	3.2	134		√
PSB220□A3B708	C	270	380	22	135	2.3	110		
PSB330□A2B707	A	270	380	33	120	0.95	40	√	√
PSB330□A2B710	B	270	380	33	120	3.2	134		√
PSB400□A2B707	A	270	380	40	120	0.95	40	√	√
PSB400□A2B710	B	270	380	40	120	3.2	134		√
PSB470□A2B707	A	270	380	47	120	0.95	40	√	√
PSB470□A2B710	B	270	380	47	120	3.2	134		√
PSB680□A2B707	A	270	380	68	120	0.95	40	√	
PSB101□A2C807	A	380	550	100	120	0.95	40	√	
PSB101□A2C810	B	380	550	100	120	3.2	134		√
PSB560□A3D408	C	440	620	56	135	2.3	110		
PSB101□A3E608	C	560	800	100	135	2.3	110		

Note: □ is the tolerance of R₂₅

■ Application and Selection

● Typical application circuit

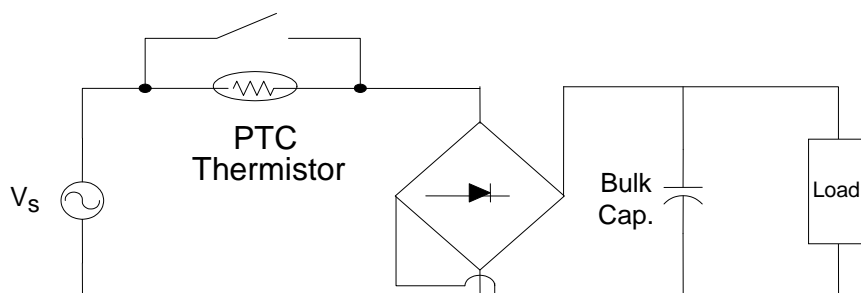

● Selection

Select charging capacitor according to the following formula.

$$C < \frac{0.7 \times (T_c - T_a) \times C_{th} \times 10^6}{0.5 \times V^2} \quad (\text{Unit: } \mu\text{F})$$

C: Bulk Cap.

T_c: Curie temperature of PTC

V: Voltage of capacitor charging ($V=1.414 \times V_s$)

0.7: Safety factor

T_a: Ambient temperature

$$E_{\text{Non60}} = 0.7 \times (T_c - T_a) \times C_{th}$$

E_{Non60}: Max Non-operating Energy at 60°C (T_a= 60)

Ceramic PTC Thermistor: PSB Series

Case Type for Inrush Current Limiter



■ R-T Characteristic Curve (Typical)

PSB *07 Series

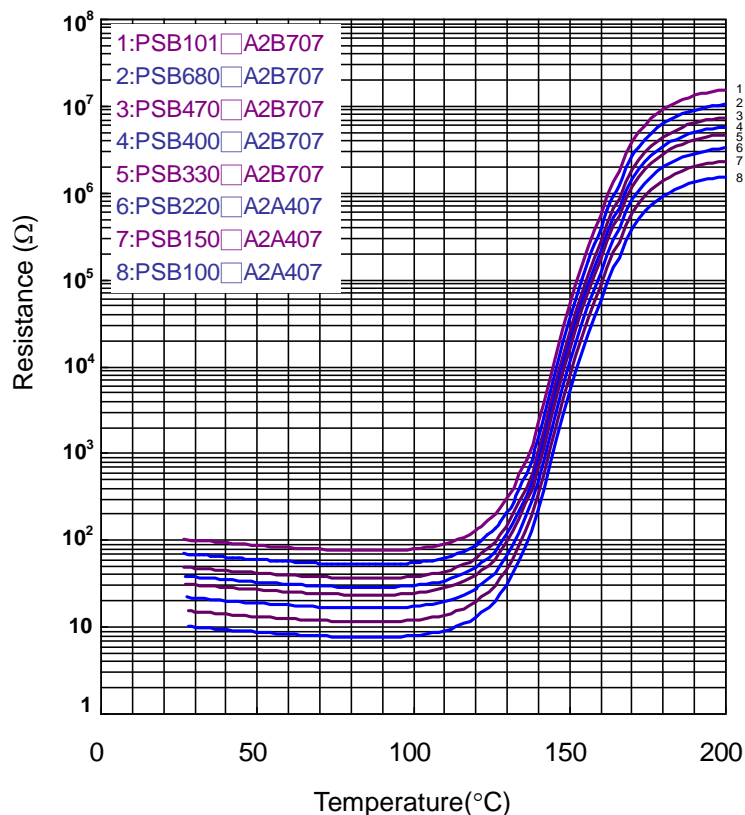

PSB *08 Series

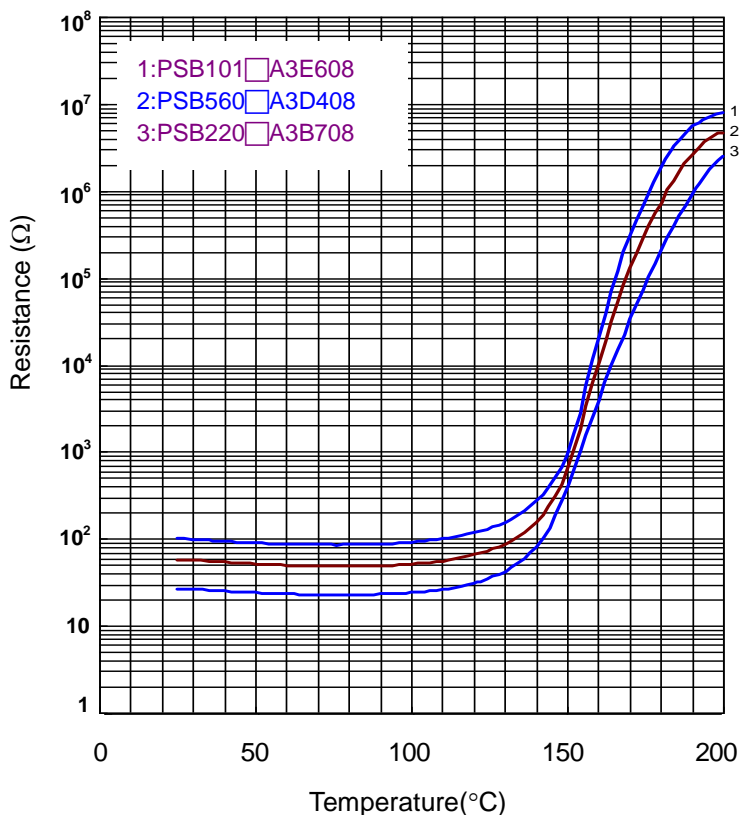

PSB *10 Series

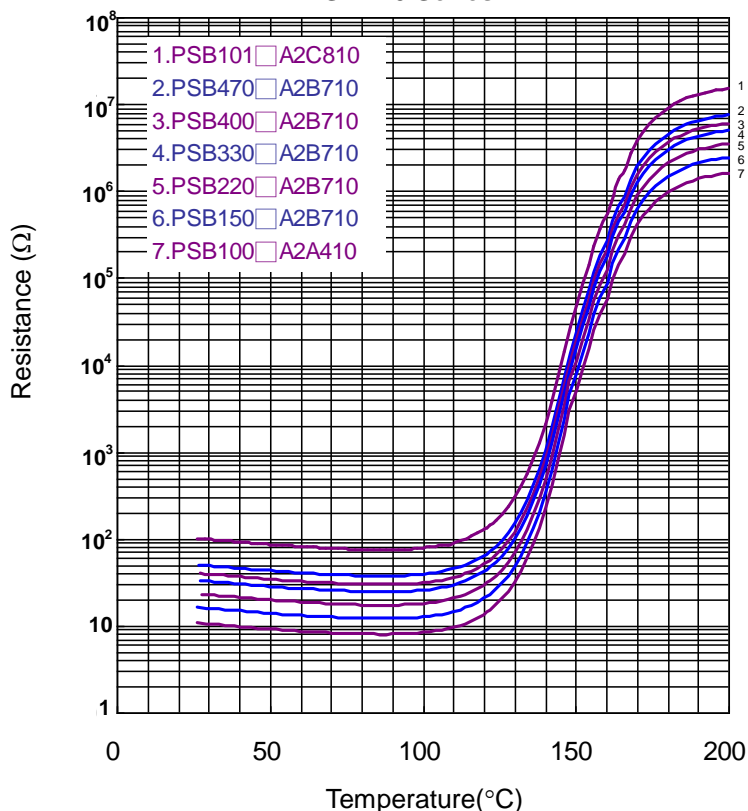

Ceramic PTC Thermistor: PSB Series

Case Type for Inrush Current Limiter



■ Soldering Recommendation

● Wave Flow Soldering Profile

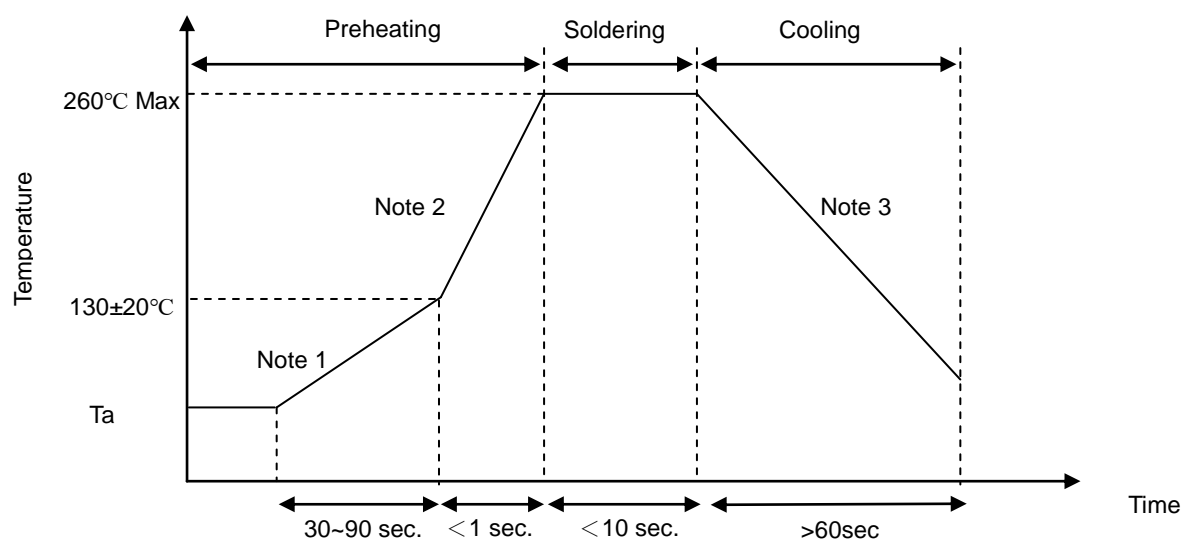

Note

- 1: $(1 \sim 3^\circ\text{C})/\text{sec}$
- 2: Approx. $200^\circ\text{C}/\text{sec}$
- 3: $5^\circ\text{C}/\text{sec. (Max)}$

■ Recommended Reworking Conditions with Soldering Iron

Item	Conditions
Temperature of Soldering Iron-tip	360°C (max.)
Soldering Time	3 sec (max.)
Distance from Thermistor	Do not touch the case bottom

Ceramic PTC Thermistor: PSB Series

Case Type for Inrush Current Limiter



■ Reliability Test

Item	Standard	Test conditions and Methods	Specifications															
Robustness of Terminations	IEC 60738-1	Gradually apply 40±0.5N and keep the unit fixed for 10±1 sec.	$\Delta R_{25}/R_{25}$ ≤ 20% No visible damage															
Solderability	IEC 60738-1	245±3°C, 2±0.5 sec	At least 95% of terminal electrode is covered by new solder															
Resistance to Soldering Heat	IEC 60738-1	260±3°C, 10±1 sec	$\Delta R_{25}/R_{25}$ ≤ 20% No visible damage															
Vibration	IEC 60738-1	Frequency range: 10~55Hz Amplitude: 0.75mm or 98m/s ² Direction: 3 mutually perpendicular directions Duration: 6hrs (3x2 hrs)	$\Delta R_{25}/R_{25}$ ≤ 20% No visible damage															
Shock	IEC 60738-1	Wave: half-sine ΔV : 1.0m/s Acceleration: 50 m/s ² Pulse time: 30ms	$\Delta R_{25}/R_{25}$ ≤ 20% No visible damage															
Rapid Change of Temperature	IEC 60738-1	The thermal shock conditions shown below shall be repeated 5 cycles. <table border="1" style="margin-left: 20px;"> <thead> <tr> <th>Step</th> <th>Temperature (°C)</th> <th>Period (minutes)</th> </tr> </thead> <tbody> <tr> <td>1</td> <td>-40 ± 5</td> <td>30 ± 3</td> </tr> <tr> <td>2</td> <td>Room temperature</td> <td>5 ± 3</td> </tr> <tr> <td>3</td> <td>85 ± 5</td> <td>30 ± 3</td> </tr> <tr> <td>4</td> <td>Room temperature</td> <td>5 ± 3</td> </tr> </tbody> </table>	Step	Temperature (°C)	Period (minutes)	1	-40 ± 5	30 ± 3	2	Room temperature	5 ± 3	3	85 ± 5	30 ± 3	4	Room temperature	5 ± 3	$\Delta R_{25}/R_{25}$ ≤ 20% No visible damage
Step	Temperature (°C)	Period (minutes)																
1	-40 ± 5	30 ± 3																
2	Room temperature	5 ± 3																
3	85 ± 5	30 ± 3																
4	Room temperature	5 ± 3																
Climatic Sequence	IEC60738-1	Dry heat: 125 °C for 16hrs Damp heat first cycle: 40°C, 95%R.H, cycle time: 24hrs Cold: -25°C for 2hrs Damp heat (cyclic), remaining cycles: 5 cycles Test according to IEC60068-2-30	$\Delta R_{25}/R_{25}$ ≤ 20% No visible damage															
Damp Heat, Steady State	IEC 60738-1	40±2°C, 90~95%RH, 1000±2hrs	$\Delta R_{25}/R_{25}$ ≤ 20% No visible damage															
Endurance at Maximum Operating Temperature and Maximum Voltage	IEC 60738-1	85±5°C, Vmax, 1000±2hrs	$\Delta R_{25}/R_{25}$ ≤ 20% No visible damage															
Endurance for Charging of Capacitor	Specification Standard	Operating cycles at Vmax >100,000 cycles (charging of capacitor)	$\Delta R_{25}/R_{25}$ ≤ 20% No visible damage															

Ceramic PTC Thermistor: PSB Series

Case Type for Inrush Current Limiter



■ Packaging

(unit:mm)

Series	PSB*07 and PSB*08 Series	PSB*10 Series
Case type	A and C	B
Quantity	50pcs per box 	25pcs per box
	20 boxes per carton 	5 boxes per carton

■ Warehouse Storage Conditions of Products

● Storage Conditions:

1. Storage Temperature: $-10^{\circ}\text{C} \sim +40^{\circ}\text{C}$
2. Relative Humidity: $\leq 75\% \text{RH}$
3. Keep away from corrosive atmosphere and sunlight.

● Period of Storage: 1 year

■ Usage

Please keep products away from the conditions mentioned below to avoid their characteristic deterioration and failure.

1. Corrosive gas or deoxidizing gas (Cl_2 , H_2S , NH_3 , SO_x , NO_x etc.)
2. Place in a vacuum or put pressure
3. Salt water, oil, solvent and chemical liquid
4. Flammable gas
5. Place in splashed water, or high humidity and dewing place
6. Other places similar to any conditions mentioned above